

LCF02 QTouch AO5DO

Fancoil controller

thermokon[®]
HOME OF SENSOR TECHNOLOGY

Datasheet

Subject to technical alteration
Issue date: 29.01.2025 • A142

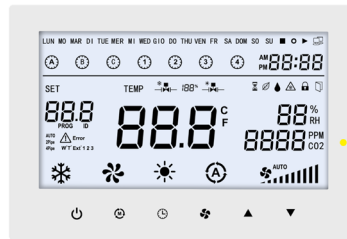

» APPLICATION

Fan coil controller for room temperature control with intuitive operation via real glass display and optional CO2 sensor with TLF function. For 3-speed or EC fans in 2- or 4-pipe operation.

» SECURITY ADVICE – CAUTION

Only approved for the intended use described in the application, unauthorized conversion or modification prohibited!

Must not be used in conjunction with devices that directly or indirectly serve human, health or life safety purposes or whose operation could pose a risk to people, animals or property.

The state of the art, applicable laws, standards and regulations at the time of installation must be applied.



Installation and assembly only by authorized electricians.

Only connect devices with a power connection if the connecting cable is disconnected!



WARNING! Danger to life due to live components!

CAUTION! Risk of electric shock! There may be live parts inside the housing. Particularly with appliances in mains voltage mode (normally between 90 and 265 V), touching live parts can result in personal injury.

» NOTES ON DISPOSAL



The crossed-out wheeled bin symbol indicates that the product or removable batteries must not be disposed of with household or commercial waste. Within the EU, you are legally obliged to dispose of the product separately and appropriately in accordance with the national laws of your country. Alternatively, please contact your supplier or Thermokon Sensortechnik GmbH. Further information can be found at: www.thermokon.com

» MOUNTING ADVISE ROOM SENSORS

The Accuracy of the room sensors are influenced by the technical specifications as well as the positioning and the installation type.

During Assembly:

- Seal mounting box (if present).
- Installation type, air draught, heat source, radiation heat or direct sunlight can affect the measurement.
- Building material specific properties of the installation place (*brick-, concrete-, cavity wall, ...*) can affect the measurement.

Assembly not recommendet in...

- Air draught (e.g.: close to windows / doors / fans ...)
- Near heating sources,
- Direct sunlight
- Niches / between furniture / ...

» TECHNICAL DATA

Measuring values	Temperature & humidity, CO2 (optional)		
Output switch contact	terminal 1 2 (for heating and cooling, 2-point control or PWM) 2 normally open contacts, max. 250 V ~ / 3 A	terminal 3 4 5 – LO ME HI (for fan) 3x normally open contact, max. 250 V ~ / 3 A	
Output voltage	terminal 11 0..10 V, min load 10kΩ		
Network technology	RS485 Modbus, RTU, half-duplex, baud rate 4.800, 9.600, 19.200 or 38.400 parity: non (2 stopbits), even or odd (1 stopbit), RS485 bus load: ¼ unit load according to RS485 standard Fail-safe Biasing required. Follow the instructions in the Modbus standard (§3.4.6.)*		
Power supply	230 V ~ / 3A		
Power consumption	3 W		
Measuring range temp.	+1..+50 °C		
Accuracy temperature	±1 K (typ. at 21 °C)		
Measuring range humidity	0..100% rH without condensation		
Accuracy humidity	±2% between 10..90% rH (typ. at 21 °C)		
Measuring range CO2	0..2000 ppm		
Accuracy CO2	±50 ppm +3 % of the measuring value (typ. at 21 °C, 50% rH, 1015 hPa)		
Inputs	terminal 9 input for external sensor NTC10K	terminal 12 – ESI input digital for floating contact, window contact, dew point sensor	terminal 13 - OCC input digital for floating contact, occupancy sensor, key card switch
Control functions	set point adjustment +1..+50 °C, (default +16..+30 °C)		
Display	LCD 102x56 mm, white or black background lighting, LED for TLF threshold indicator (CO2)		
Enclosure	ABS, pure white or black		
Protection	IP20 according to EN 60529		
Cable entry	rear entry		
Connection electrical	terminal block max. 1,5 mm ²		
Ambient condition	-10..+50 °C, max. 95% rH non-condensing		
Mounting	flush mounted with standard EU box (Ø=60 mm, at min 45mm depth)		

*Modbus Standard https://modbus.org/docs/Modbus_over_serial_line_V1_02.pdf



» PRODUCT TESTING AND CERTIFICATION



Declaration of conformity

The declaration of conformity of the products can be found on our website
<https://www.thermokon.de/direct/en-gb/categories/lcf02-qtouch>

» CONNECTION PLAN

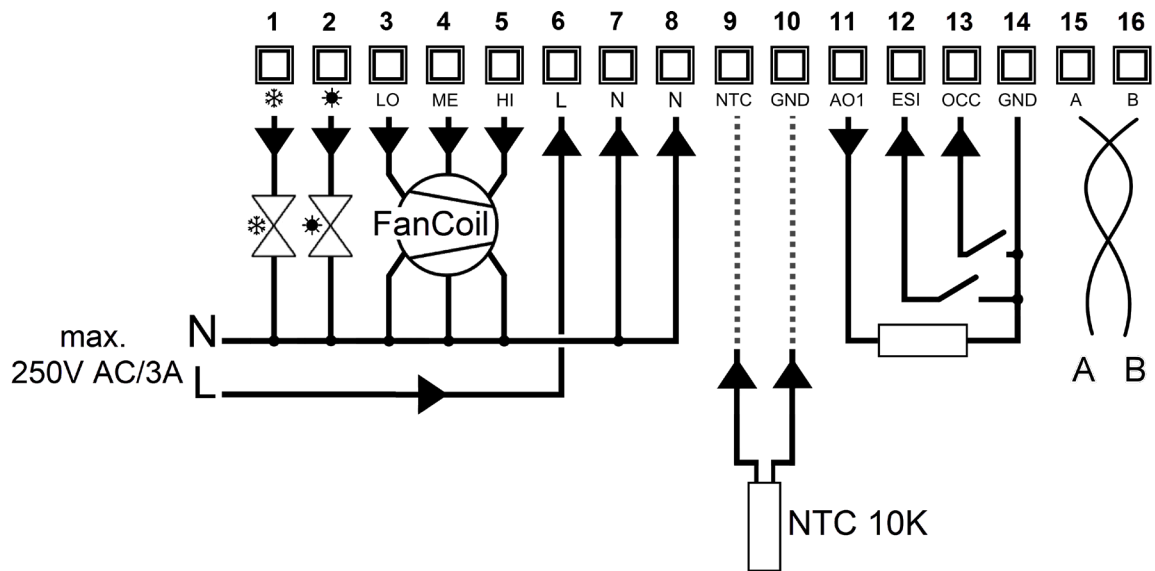

Power supply

If several devices are connected to one power supply, make sure that all "positive" operating voltage inputs (+) and all "negative" operating voltage inputs (-) of the devices are connected to each other (in-phase connection of the devices).

If the polarity of the supply voltage on one of the devices is reversed, the device may be damaged.

» DISPLAY PANEL

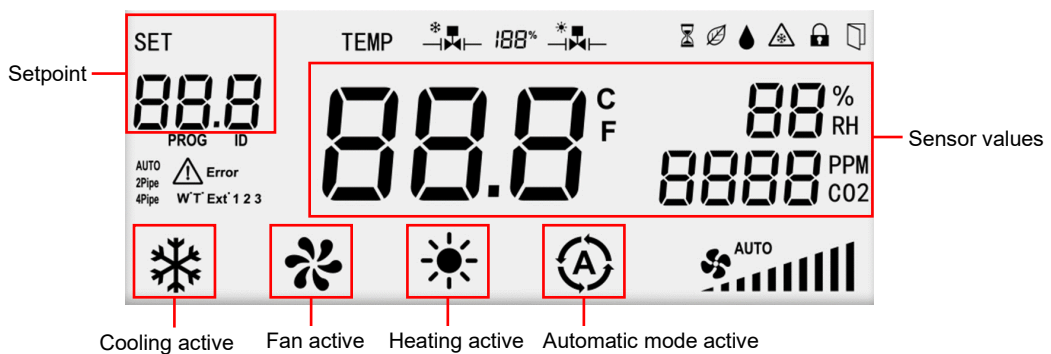
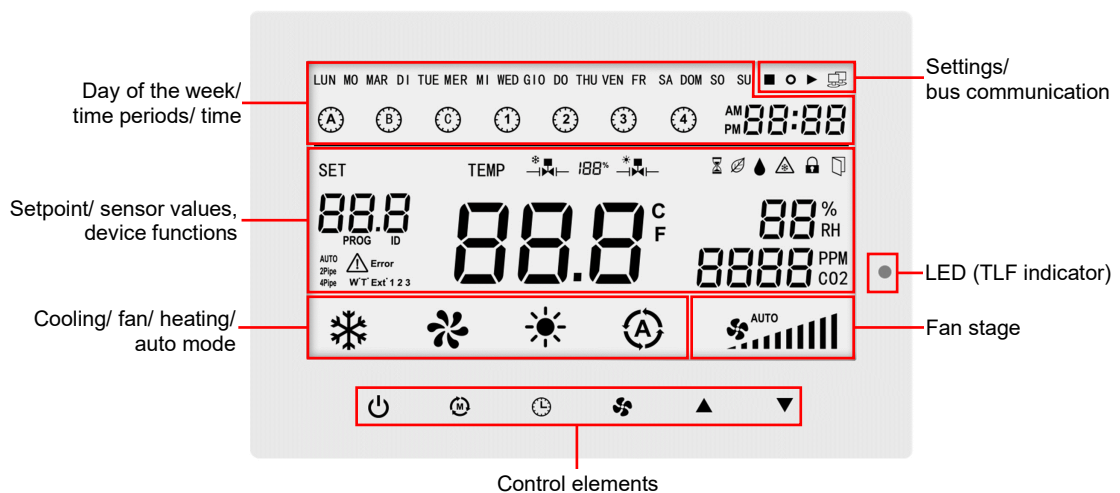

Additional symbols



	cooling valve	188%	Control value		Heating valve		Fan overrun		Dewpoint reached		Buttons locked		
AUTO 2Pipe 4Pipe	Fancoil type		Error message		Warning sign	W'T Ext' 1 2 3	External sensor usage		ECO mode		Frost protection „Off“		Window „open“

» **DEVICE CONFIGURATION**

Device information		The device software version is shown on the display during startup (top right corner).
Bus communication		Symbol flashes (If the device does not communicate via the bus, the symbol will be disappear after 10 seconds)
Parameter menu		To enter the parameter menu (i.e. for Modbus-communication settings): - Press and hold "mode" and up-button for 4 seconds. - Enter password: (default: 987) <ul style="list-style-type: none"> o Digit selection: mode-button o Arrow keys (▲/▼): increase / decrease value - Select parameter with arrow keys
Date/time settings		- press and hold the Time/Calendar and Temperature "Down" buttons simultaneously for 5 seconds - parameterisable value starts to flash - year/month/day/hour can be set sequentially - value can be changed with the "Up" and "Down" buttons - confirmed with the time/calendar button



After parameter selection / setting, don't press any button for 3 seconds to save the settings.

Operating status after voltage loss (register 268)		The device remains switched off (standby)
		The device restores the original operating status.
		The device is switched on



The operating status is saved during a voltage loss and can be reset after voltage recovery depending on the setting. **The setpoint is not saved. The standard setpoint value (register 271) applies after voltage loss.**

No.	Parameter	Description	default
1	Modbus Address	ID.1- ID.247	1
2	Baud rate	1 = 4800bps 2 = 9600 3 = 19200 4 = 38400	2
3	Parity	0 = none 1 = odd 2 = even	0
4	Stop Bits	1 = 1 Stopbit 2 = 2 Stopbits (8 data bits)	2
5	Temperature Offset (register 262) internal sensor	-5,0 K..+5,0 K	0
6	Temperatur Offset (register 263) external sensor	-5,0 K..+5,0 K	0
7	Screensaver mode	0 = display button on / off 1 = room temperature and button on / off 2 = display clock, room temperature and button on / off 3 = display clock, room temperature / button on / off and set point 4 = display all status	0
8	7 day 4 periods (programmable)	0 = deactivated 1 = activated	0
9	Password (Register 265)	0..999	987
10	Factory reset	- Set parameter to 1 - Press mode key - Device is factory reset. (Device stays in Parameter menu for Modbus configuration)	0

°F/°C selective



Temp display range is 32 °F..99 °F, respectively 0 °C..50 °C (factory default is °C). By simultaneously pressing the keys "▲" and "▼" the display of the unit system can be switched directly on the LCD.

Key lock selection (Register address 0x010D)

Its possible to set a key lock function. If a locked key is pressed, the lock symbol will appear for 2s and blink 2x but no further action is taken.

» **CONTROLLER OUTPUT SIGNAL**

The Fancoil controller is designed for fan coil units with 2- or 4-pipe systems for heating and cooling.

		4-pipe (default)	2-pipe
Terminal 2		Cooling	Heating & Cooling
Terminal 3		Heating	

PI-controller 0..10 V

The manipulated variable is output as a proportional control signal. The type of valve used is set via the configuration registers.





6WV

With register address 304, a 6-way valve can also be selected as valve type. You can choose from 2..10 V / 2..10 V INV (Belimo), 0..10 V DN15 / DN15 INV, DN20 / DN20 INV (Sauter).

EC-Fan

Register address 360 can be used to configure the control of an EC fan via the analog output, among other things.

» **FUNKTIONAL DESCRIPTION**

Operating mode		Cooling > Auto > ventilation > heating ...	With 2-pipe configuration, the unavailable modes (depending on the change-over status) are skipped. Only available modes can be selected!
Power button		Standby > ECO > ON ...	Operating mode switchover on the device. Standby mode = display off, frost protection active. (Temperature threshold register 298 - Standard 7 °C). (terminal 13 – OCC switchable)
ECO-Mode		ECO setpoint (registers 275 and 276 (0x0113, 0x0114), Setpoint adjustment on the device by the user is not possible, Display leaf symbol + ECO lettering (terminal 12 – ESI switchable)	
Fan stage		Fan stage 1 > ..2 > ..3 > ..Auto ...	Auto (fan speed dependent on controller variable) Number of fan speeds configurable
Setpoint adjustment		Default: +16..+30 °C (+60..+86 °F) (register 272 – 273)	

Temperature sensor input - temperature limitation and external temperature sensor

The temperature sensor input terminal 9 (address 0x0152) can be used as a change over sensor (addresses 0x012B and 0x012C) or as an external temperature sensor.

It can also be used to limit the heating temperature (address 0x010A) and cooling temperature (address 0x010B). This is the case with underfloor heating systems where the external sensor is embedded in the floor. If the floor temperature exceeds a certain limit, the heating valve must be closed to prevent damage to the floor or the pipes embedded in the floor.

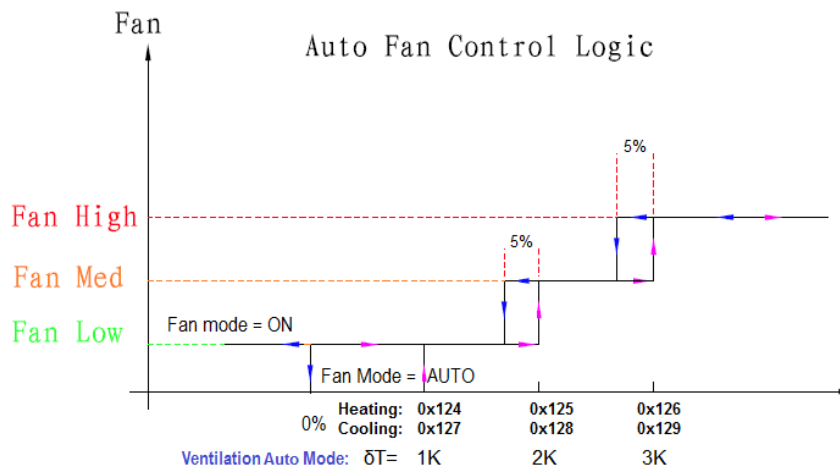

Room occupancy (OCC)

If the digital input (OCC) reports "Room unoccupied", the "Eco Mode" setpoint is activated. The "Eco Mode" leaf symbol appears in the display and the ECO lettering in the setpoint display. When switching to "Occupied" mode, the sheet symbol disappears again.

Window contact (ESI)

If the input is configured as a window contact or dew point sensor, it is checked every 3 seconds. If "Window open" or "Dew point reached", the respective symbol appears and the valve is closed.

Sensor alarm (register address 0x0009)

If an error is detected in the internal temperature sensor (e.g. short circuit or cable break), the switch-on time of a PWM cycle is reduced by 50% and the active output is set to 50% actuating value.

The display flashes the error code: "E1" The thermostat enables manual control of the fan and valve output using the "▲" or "▼" buttons. Each time the "▲" or "▼" buttons are pressed, the output voltage is reduced or increased by 1 V = 10% and the PWM by 10%. The percentage is shown on the display.

» REGISTER DESCRIPTION

Input Register		Register value \triangleq Value range		
Address	Access	Description		
0	0x0000	R	Thermokon model identification	
1	0x0001	R	Firmware-Version	z.B. 0x1A20 \triangleq 1.10.2.0
2	0x0002	R	Back-Box Type	
3	0x0003	R	Value of the integrated temperature sensor °C / °F	0..500 \triangleq 0..50,0°C 300..1200 \triangleq +30,0..+120,0°F
4	0x0004	R	Fan-State 0b00000000 = OFF 0b00000001 = Fan stage low 0b00000010 = Fan stage medium 0b00000100 = Fan stage high 0b00001000 = Auto OFF 0b00001001 = Auto low 0b00001010 = Auto medium 0b00001100 = Auto high	
5	0x0005	R	VA1 State – output valve 1 cooling	0..1000 \triangleq 0..100%
6	0x0006	R	VA2 State – output valve 2 heating	0..1000 \triangleq 0..100%
7	0x0007		Reserved	
8	0x0008	R	External temperature sensor °C / °F	-200..+1000 \triangleq -20,0..+100,0°C 0..2100 \triangleq 0,0..+210,0°F
9	0x0009	R	Failure status 0x00= no failure 0x01= control loop temperature sensor alarm 0x02= external temperature sensor high limit alarm – (cablebreak) 0x04= external temperature sensor low limit alarm – (short circuit) 0x08= change over sensor missing alarm	
10	0x000A	R	External input 1 – terminal 11 0 = Contact open, 1= Contact closed <i>(i.e. window contact, dew point sensor)</i>	0..1
11	0x000B	R	External input 2 – terminal 12 0 = Contact open, 1= Contact closed <i>(i.e. OCC Sensor, keycard-switch)</i>	0..1

		Holding Register				
		Address	Access	Description	Register value \triangle Value range	Default
General settings	256	0x0100	R/W	Customer set Device location identification	0..65535	0
	257	0x0101	R/W	LCD temperature Unit 0 =°C 1=°F (converted values)	0..1	0
	258	0x0102	R/W	Volume touch sound 0=Off 1..5 (Volume)	0..5	5
	259	0x0103	R/W	Backlight intensity (operation)	0..100 \triangle 0..100%	80
	260	0x0104	R/W	Backlight intensity for screen saver	0..25	20
	261	0x0105	R/W	Backlight operating delay setting	1..255 \triangle 1..255 Sec. (on)	15
	262	0x0106	R/W	Internal Sensor Temperature Offset (added to measured value)	-50..50 \triangle -5,0..+5,0 [°C] -250..250 \triangle -25,0..+25,0 [°F]	0
	263	0x0107	R/W	external Sensor Temperature Offset (added to measured value)	-50..50 \triangle -5,0..+5,0 [°C] -250..250 \triangle -25,0..+25,0 [°F]	0
	264	0x0108	R/W	Display language 0= german 1= english 3= italian	0..3	0
	265	0x0109	R/W	Individual passwords setting 001-999 default=987 000 = no password	000..999	987
	266	0x010A	R/W	External temperature (limiter) sensor high limit (338=3, for limiter)	-200..1000 \triangle -20,0..+100,0 [°C] 0..2100 \triangle 0,0..+210,0 [°F]	400 / 110
	267	0x010B	R/W	External temperature (limiter) sensor low limit (338=3, for limiter)	-200..1000 \triangle -20,0..+100,0 [°C] 0..2100 \triangle 0,0..+210,0 [°F]	0 / 320
	268	0x010C	R/W	Power failure 0= keep off after power-on-reset 1= return to last state after power failure 2= switch on after power-on-reset	0..2	1
	269	0x010D	R/W	Key-lock Once a locked key is pressed the LOCK symbol shall be displayed and blink twice. 0x00=unlocked 0x01=lock on/off 0x02=lock mode 0x08=lock fan speed 0x10=lock temp settings + / - 0x1F=lock all keystrokes		0
270	0x010E	R/W	Display settings 0b00000001= show setpoint (if no setpoint is shown, keys are locked) 0b00000010= show room temperature 0b00000100 = show valve symbol 0b00001000 = show PI-loop percentage 0bxxx10000 = show room temperature from register 0x205 (touch only)		15	

		Holding Register				
		Address	Access	Description	Register value \triangle value range	default
Set-point settings	271	0x010F	R/W	Default Setpoint after Power On Reset	0..500 \triangle 0,0..+50,0 [°C] 300..1200 \triangle +30,0..+120,0 [°F]	210 / 700
	272	0x0110	R/W	Setpoint temperature lower limit	0..500 \triangle 0,0..+50,0 [°C] 300..1200 \triangle +30,0..+120,0 [°F]	160 / 600
	273	0x0111	R/W	Setpoint temperature upper limit	0..500 \triangle 0,0..+50,0 [°C] 300..1200 \triangle +30,0..+120,0 [°F]	300 / 860
	274	0x0112	R/W	Setpoint increment/decrement value	1..100 \triangle 0,1..10,0 [°C] 1..500 \triangle 0,1..50,0 [°F]	5 / 10
	275	0x0113	R/W	ECO mode temperature setpoint cooling	250..450 \triangle +25,0..45,0 [°C] 750..1100 \triangle +75,0..110,0 [°F]	300 / 860
	276	0x0114	R/W	ECO mode temperature setpoint heating	120..240 \triangle +12,0..24,0 [°C] 50..750 \triangle +5,0..75,0 [°F]	190 / 660

		Holding Register					
		Address	Access	Description	Register value \triangle Value range default.		
PI-controller	277	0x0115	R	Controller mode Comfort: 0b0000 0000= Controller off (frost protection active, LCD off) 0b0000 0001= Controller auto mode (heating & cooling) 0b0000 0010= Controller heating mode only 0b0000 0011= Controller cooling mode only 0b0000 0100= ventilating (PI-loop controls fan stages only, valves closed) Regler-Modus ECO: 0b0001 0000= Controller off (Frost protection active) 0b0001 0001= Controller auto mode (heating&cooling) 0b0001 0010= Controller heating mode only 0b0001 0011= Controller cooling mode only 0b0001 0100= ventilating (PI-loop controls fan stages only, valves closed)	1		
	278	0x0116	R/W	Fancoil Typ: 2- or 4-pipe 0b00000000=2-pipe: cooling + heating with change over 0b00000001=4-pipe: cooling + heating / (or if 6WV used) 0b000000xx=symbol not shown 0b000001xx=symbol shown	1		
	279	0x0117	R/W	Fan stages and operation modes 0b00000000 = none (fan key is locked, the fan symbol will be faded on the LCD) 0bxxxx0001 = 1 fan stage 0bxxxx0010 = 2 fan stages 0bxxxx0011 = 3 fan stages 0b0001xxxx = During heating mode fan is disabled 0b0010xxxx = During cooling/ventilation mode fan is disabled 0b0011xxxx = during heating/ cooling mode fan is disabled	3		
	280	0x0118	R/W	Start fan at highest stage for () seconds	0.60 \triangle 0..60 Sek.	0	
	281	0x0119	R/W	Fan OFF-Delay 0= fan never stops 1..255 \triangle 1..255 Min after valve closing fan stops for .. minutes.	15		
	282	0x011A	R/W	PWM 0 = for 2 point controller (i.e. for electrical heater) 1...255 \triangle 1...255 minutes PWM-cycle time	15		
	283	0x011B	R/W	Deadband	1..100 \triangle 0,1..10,0 [°C]	10	
	284	0x011C	R/W	Heating Proportional Band Xp_heat	1..100 \triangle 0,1..10,0 [°C]	20	
	285	0x011D	R/W	Heating Integration Time Tn_heat	0..255 \triangle 0..255 Minuten	30	
	286	0x011E	R/W	Cooling Proportional Band Xp_cool	1..100 \triangle 0,1..10,0 [°C]	20	
	287	0x011F	R/W	Cooling Integration Time Tn_cool	0..255 \triangle 0..255 Minuten	30	
	288	0x0120	R/W	Minimal limit of the control variable heat	0..100 \triangle 0..100 %	0	
	289	0x0121	R/W	Maximal limit of the control variable heat	0..100 \triangle 0..100 %	100	
	290	0x0122	R/W	Minimal limit of the control variable cool	0..100 \triangle 0..100 %	0	
	291	0x0123	R/W	Maximal limit of the control variable cool	0..100 \triangle 0..100 %	100	
	292	0x0124	R/W	Fan stage 1 ON threshold control variable heat	0..100 \triangle 0..100 %	5	
	293	0x0125	R/W	Fan stage 2 ON threshold control variable heat	0..100 \triangle 0..100 %	35	
	294	0x0126	R/W	Fan stage 3 ON threshold control variable heat	0..100 \triangle 0..100 %	70	
	295	0x0127	R/W	Fan stage 1 ON threshold control variable cool	0..100 \triangle 0..100 %	5	
	296	0x0128	R/W	Fan stage 2 ON threshold control variable cool	0..100 \triangle 0..100 %	35	
	297	0x0129	R/W	Fan stage 3 ON threshold control variable cool	0..100 \triangle 0..100 %	70	
	298	0x012A	R/W	Frost protection temperature threshold	50..150 \triangle +5,0..+15,0 °C 400..600 \triangle +40,0..+60,0 °F	70/ 450	
	299	0x012B	R/W	Change-Over Temperature Threshold for Heating	0..500 \triangle 0..+50,0 °C 300..1200 \triangle +30,0..+120,0 °F	300/ 860	
	PI-controller	300	0x012C	R/W	Change-Over Temperature Threshold for Cooling <i>(In case temperature is in between both thresholds the last state will be maintained)</i>	0..500 \triangle 0..+50,0 °C 300..1200 \triangle +30,0..+120,0 °F	190/ 660
		301-303			Reserved		
		304	0x0130	R/W	Valve type selection, heating + cooling 0 = 2-p.-3-p.-controller / ON-OFF ON \triangle Valve open, OFF \triangle Valve closed 1 = PI-controller PWM 0..100 \triangle 0-100%PWM 2 = 2-p.-3-p.-controller / OFF-ON OFF \triangle Valve open, ON \triangle Valve closed 3 = PI-controller inverted PWM 0%= 100%PWM .. 100% = 0% PWM 4= proportional (0V = 0% ..10V = 100%) 5= invers proportional (0V = 100% ..10V = 0%)	6= proportional Belimo 6 way 7= proportional Sauter 6 way with Ø15mm 8= proportional Sauter 6 way with Ø20mm 9= proportional Belimo 6 way, counter direction 10= proportional Sauter 6 way with Ø15mm, counter direction 11= proportional Sauter 6 way with Ø20mm, counter direction 12= no valve	4

Holding Register						
Address		Access	Description	Register value \triangle Value range	default	
Inputs	336	0x0150	R/W	Configuration external input 1, terminal 12 0 = no function 1 = Occupancy sensor (Open = Occupied) 2 = Occupancy sensor (Closed =Occupied) 3 = Window contact (Open = Window Open) 4 = Window contact (Closed = Window Open) 5 = Disable heating (Open = Heating disabled) 6 = Disable heating (Closed = Heating disabled) 7 = Disable cooling (Open = Disable Cooling) 8 = Disable cooling (Closed = Disable Cooling) 9 = Dew Point Sensor (Open = Dewpoint crossed, disable cooling) 10 = Dew Point Sensor (Closed = Dewpoint crossed, disable cooling)	0	
	337	0x0151	R/W	Configuration external input 2, terminal 13 0 = No function 1 = Occupancy sensor (Open = Occupied) 2= Occupancy sensor (Closed =Occupied) 3 = Window contact (Open = Window Open) 4 = Window contact (Closed = Window Open) 5 = Disable heating (Open = Heating disabled) 6 = Disable heating (Closed = Heating Disabled) 7 = Disable cooling (Open = Disable Cooling) 8 = Disable cooling (Closed = Disable Cooling) 9 = Dew Point Sensor (Open = Dewpoint crossed, disable cooling) 10 = Dew Point Sensor (Closed = Dewpoint crossed, disable cooling)	0	
	338	0x0152	R/W	Configuration Sensor Input 0 = none connected 1 = Change-Over Temp sensor (NTC10K) 2 = Ext. temp sensor (NTC10K) 3 = Temperature limiter	0	
	339	0x0153	R/W	ESI (Energy Savings Input) – ON delay ON delay for ESI. Delays Energy stop by n seconds.	[s]	0
	340	0x0154	R/W	Occupation (OCC-input) – OFF- delay	0...65535 \triangle 0...65535 [s]	1800

Holding Register						
Address		Access	Description	Register value \triangle Value range	default	
Sensor values Humidity / CO2	350	0x015E	R	Measured value of the integrated Humidity - sensor	0..100 \triangle 0..100 [%rH]	
	351	0x015F	R/W	Humidity Offset	-50 .. +50 \triangle -50 .. +50 [%rH]	0
	354	0x0162	R/W	Ambient pressure for CO2-compensation	970 hPa \triangle 97 kPa	100
	355	0x0163	R	Measured value of the integrated CO2-sensor	0..5000 \triangle 0..5000 [ppm]	
	356	0x0164	R/W	CO2 offset	-1000 .. +1000 \triangle -1000 .. +1000 [ppm]	0
	357	0x0165	R/W	TLF threshold value yellow	0..5000 \triangle 0..5000 [ppm] 0 = deactivated	750
	358	0x0166	R/W	TLF threshold value red	0..5000 \triangle 0..5000 [ppm]	1250
	359	0x0167	R/W	TLF LED brightness	0..100 \triangle 0..100 [%]	80

		Holding Register				
		Address	Access	Description	Register value \triangleq Value range	default
Analog Output (AO)	360	0x0168	R/W	AO Function	0=Deactivated / External override 1=EC-fan 2=CO2 sensor value 3=CO2 controller 4=6 way valve 5=6 way valve with digital input changeover (connected with cooling valve DO) 6=Cooling valve	0
	361	0x0169	R/W	AO value	0..1000 \triangleq 0..10V /Override if register 360 = 0	
	362	0x016A	R/W	AO heating voltage 0% (6 way valve)	0..1000 \triangleq 0..10V	0
	363	0x016B	R/W	AO heating voltage 100% (6 way valve)	0..1000 \triangleq 0..10V	1000
	364	0x016C	R/W	AO cooling voltage 0% (6 way valve)	0..1000 \triangleq 0..10V	0
	365	0x016D	R/W	AO cooling voltage 100% (6 way valve)	0..1000 \triangleq 0..10V	1000
	366	0x016E	R/W	AO CO2 controller minimum voltage	0..1000 \triangleq 0..10V	0
	367	0x016F	R/W	AO CO2 controller maximum voltage	0..1000 \triangleq 0..10V	1000
	368	0x0170	R/W	AO controller minimal value	Register 360 = 3: 0..100 \triangleq 0..100% Register 360 = 2: 0..5000 \triangleq 0..5000ppm	0
	369	0x0171	R/W	AO controller maximal value	Register 360 = 3: 0..100 \triangleq 0..100% Register 360 = 2: 0..5000 \triangleq 0..5000ppm	100 / 2000
	370	0x0172	R/W	AO Live Zero configuration	0 = Live Zero deactivated 1 = Live Zero AO 1..10V 2 = Live Zero AO 2..10V	
	380	0x017C	R/W	DO Changeover (register 360 = 5)	0 = DO Normal (heating: closed, cooling: open) 1 = DO Invertiert (heating: open, cooling: closed)	0

Holding Register						
Address	Access	Description	Register value \triangle Value range	default		
Timer	400	0x0190	R/W	Clock mode configuration 0=Don't show time in LCD 1=12h mode 2=24h mode	0..2	2
	401	0x0191	R/W	Weekday configuration 0=OFF 1=ON	0..1	1
	402	0x0192	R/W	Automatic Summer/winter time 0=OFF 1=EU automatic (last Sunday in March (+1h) - last Sunday in October (-1h)) 2=US automatic (2nd Sunday in March (+1h) - 1st Sunday in November (-1h)) 3=AUS automatic (First Sunday in October (+1h) - 1st Sunday in April (-1h)) 4=BR automatic (First Sunday in November (+1h) - Third Sunday in February (-1h)) 5=CHL automatic (Second Sunday in August (+1h) - Second Sunday May (-1h)) 6=ISR (Friday before last Sunday in March + 1h) - Last Sunday in October (-1h) 7=MEX (First Sunday in April (+1h) - Last Sunday in October (-1h)) The time is switched 2.00 am -> 3.00 am and 3.00 am -> 2.00 am		1
	403	0x0193	R/W	Time channel A weekdays 0bxxxxxxx1 Bit0: Monday 0bxxxxxx1x Bit1: Tuesday 0bxxxxx1xx Bit2: Wednesday 0bxxxx1xxx Bit3: Thursday 0bxxx1xxxx Bit4: Friday 0bxx1xxxxx Bit5: Saturday 0bx1xxxxxx Bit6: Sunday		0
	404	0x0194	R/W	Time channel A period 1: Start time hour	0..23 \triangle 0 – 23h	0
	405	0x0195	R/W	Time channel A period 1: Start time minute	0..59 \triangle 0 – 59m	0
	406	0x0196	R/W	Time channel A period 1: Set point	0..500 \triangle 0..50,0°C 300..1200 \triangle +30,0..+120,0°F	210/ 700
	407	0x0197	R/W	Time channel A period 1: ECO mode 0b00000001= Comfort 0b00010001=ECO		1
	408	0x0198	R/W	Time channel A period 2: Start time hour	0..23 \triangle 0 – 23h	0
	409	0x0199	R/W	Time channel A period 2: Start time minute	0..59 \triangle 0 – 59m	0
	410	0x019A	R/W	Time channel A period 2: Set point	0..500 \triangle 0..50,0°C 300..1200 \triangle +30,0..+120,0°F	210/ 700
	411	0x019B	R/W	Time channel A period 2: ECO mode 0b00000001=Comfort 0b00010001=ECO		1
	412	0x019C	R/W	Time channel A period 3: Start time hour	0..23 \triangle 0 – 23h	0
	413	0x019D	R/W	Time channel A period 3: Start time minute	0..59 \triangle 0 – 59m	0
	414	0x019E	R/W	Time channel A period 3: Set point	0..500 \triangle 0..50,0°C 300..1200 \triangle +30,0..+120,0°F	210/ 700
	415	0x019F	R/W	Time channel A period 3: ECO mode 0b00000001=Comfort 0b00010001=ECO		1
	416	0x01A0	R/W	Time channel A period 4: Start time hour	0..23 \triangle 0 – 23h	0
	417	0x01A1	R/W	Time channel A period 4: Start time minute	0..59 \triangle 0 – 59m	0
	418	0x01A2	R/W	Time channel A period 4: Set point	0..500 \triangle 0..50,0°C 300..1200 \triangle +30,0..+120,0°F	210/ 700
	419	0x01A3	R/W	Time channel A period 4: ECO mode 0b00000001=Comfort 0b00010001=ECO		1

Holding Register						
Address	Access	Description	Register value \pm value range	default		
420	0x01A4	R/W	Time channel B weekdays 0bxxxxxx1 Bit0: Monday 0bxxxxxx1x Bit1: Tuesday 0bxxxxxx1xx Bit2: Wednesday 0bx1xxxxxx Bit6: Sunday	0bxxxx1xxx Bit3: Thursday 0bxxx1xxxx Bit4: Friday 0bxx1xxxxx Bit5: Saturday 0bx1xxxxxx Bit6: Sunday	0	
421	0x01A5	R/W	Time channel B period 1: Start time hour	0..23 \pm 0 – 23h	0	
422	0x01A6	R/W	Time channel B period 1: Start time minute	0..59 \pm 0 – 59m	0	
423	0x01A7	R/W	Time channel B period 1: Set point	0..500 \pm 0..50,0°C 300..1200 \pm +30,0..+120,0°F	210/ 700	
424	0x01A8	R/W	Time channel B period 1: ECO mode 0b00000001=Comfort 0b00010001=ECO		0	
425	0x01A9	R/W	Time channel B period 2: Start time hour	0..23 \pm 0 – 23h	0	
426	0x01AA	R/W	Time channel B period 2: Start time minute	0..59 \pm 0 – 59m	0	
427	0x01AB	R/W	Time channel B period 2: Set point	0..500 \pm 0..50,0°C 300..1200 \pm +30,0..+120,0°F	210/ 700	
428	0x01AC	R/W	Time channel B period 2: ECO mode 0b00000001=Comfort 0b00010001=ECO		0	
429	0x01AD	R/W	Time channel B period 3: Start time hour	0..23 \pm 0 – 23h	0	
430	0x01AE	R/W	Time channel B period 3: Start time minute	0..59 \pm 0 – 59m	0	
431	0x01AF	R/W	Time channel B period 3: Set point	0..500 \pm 0..50,0°C 300..1200 \pm +30,0..+120,0°F	210/ 700	
432	0x01B0	R/W	Time channel B period 3: ECO mode 0b00000001=Comfort 0b00010001=ECO		0	
433	0x01B1	R/W	Time channel B period 4: Start time hour	0..23 \pm 0 – 23h	0	
434	0x01B2	R/W	Time channel B period 4: Start time minute	0..59 \pm 0 – 59m	0	
435	0x01B3	R/W	Time channel B period 4: Set point	0..500 \pm 0..50,0°C 300..1200 \pm +30,0..+120,0°F	210/ 700	
436	0x01B4	R/W	Time channel B period 4: ECO mode 0b00000001=Comfort 0b00010001=ECO		0	
437	0x01B5	R/W	Time channel C weekdays 0bxxxxxx1 Bit0: Monday 0bxxxxxx1x Bit1: Tuesday 0bxxxxxx1xx Bit2: Wednesday 0bxxxx1xxx Bit3: Thursday 0bxxx1xxxx Bit4: Friday 0bxx1xxxxx Bit5: Saturday 0bx1xxxxxx Bit6: Sunday		0	
438	0x01B6	R/W	Time channel C period 1: Start time hour	0..23 \pm 0 – 23h	0	
439	0x01B7	R/W	Time channel C period 1: Start time minute	0..59 \pm 0 – 59m	0	
440	0x01B8	R/W	Time channel C period 1: Set point	0..500 \pm 0..50,0°C 300..1200 \pm +30,0..+120,0°F	210/ 700	
441	0x01B9	R/W	Time channel C period 1: ECO mode 0b00000001=Comfort 0b00010001=ECO		0	
442	0x01BA	R/W	Time channel C period 2: Start time hour	0..23 \pm 0 – 23h	0	
443	0x01BB	R/W	Time channel C period 2: Start time minute	0..59 \pm 0 – 59m	0	
444	0x01BC	R/W	Time channel C period 2: Set point	0..500 \pm 0..50,0°C 300..1200 \pm +30,0..+120,0°F	210/ 700	
445	0x01BD	R/W	Time channel C period 2: ECO mode 0b00000001=Comfort 0b00010001=ECO		0	
446	0x01BE	R/W	Time channel C period 3: Start time hour	0..23 \pm 0 – 23h	0	
447	0x01BF	R/W	Time channel C period 3: Start time minute	0..59 \pm 0 – 59m	0	
448	0x01C0	R/W	Time channel C period 3: Set point	0..500 \pm 0..50,0°C 300..1200 \pm +30,0..+120,0°F	210/ 700	
449	0x01C1	R/W	Time channel C period 3: ECO mode 0b00000001=Comfort 0b00010001=ECO		0	
450	0x01C2	R/W	Time channel C period 4: Start time hour	0..23 \pm 0 – 23h	0	
451	0x01C3	R/W	Time channel C period 4: Start time minute	0..59 \pm 0 – 59m	0	
452	0x01C4	R/W	Time channel C period 4: Set point	0..500 \pm 0..50,0°C 300..1200 \pm +30,0..+120,0°F	210/ 700	
453	0x01C5	R/W	Time channel C period 4: ECO mode 0b00000001=Comfort 0b00010001=ECO		0	

Timer

Holding Register						
	Address	Access	Description	Register value \triangle Value range	default	
Timer	454	0x01C6	R/W	Active Time Channel 0bABC1234 with binary value = 1 for active channel	(i.e. 0x01000100 = A-2)	0
	464	0x01D0	R/W	Make next day(s) holiday 0bxxx00000= None 0bxxx00001 ...0bxxx11111 days of holidays (next n-days (starting next 0:00) forces the coming 1...31 days to be treated as the day specified by the 3 MSB. Does overwrite the calendar. 0b000xxxxx = use ECO setting 0b001xxxxx = set day = Mo 0b010xxxxx = set day = Tu 0b011xxxxx = set day = Wed 0b100xxxxx = set day = Thu 0b101xxxxx = set day = Fr 0b110xxxxx = set day = Sat 0b111xxxxx = set day = Sun		0

Holding Register						
	Address	Access	Description	Register value \triangle value range	default	
Realtime Clock	496	0x01F0	R/W	system time year	2000..2099	2019
	497	0x01F1	R/W	system time month	1..12	1
	498	0x01F2	R/W	system time day	1..31	1
	499	0x01F3	R/W	system time hour	0..23	0
	500	0x01F4	R/W	system time minute	0..59	0
	501	0x01F5	R/W	system time seconds	0..59	0

Holding Register (operation to override FC from modbus)						
	Address	Access	description	Register value \triangle Value range	default	
Special	512	0x0200	R/W	Active fan speed setting 0b00000000 = OFF 0b00000001 = Stage low 0b00000010 = Stage medium 0b00000100 = Stage high	0b00001000 = Auto OFF 0b00001001 = Auto low 0b00001010 = Auto medium 0b00001100 = Auto high	0
	513	0x0201	R/W	setpoint temperature	0..500 \triangle 0..+50,0 [°C] 300..1200 \triangle +30..+120,0 [°F]	0
	514	0x0202	R/W	Controller mode Comfort: 0b0000 0000= controller off (<i>Frost protection active</i>) 0b0000 0001= controller auto mode (<i>heating + cooling</i>) 0b0000 0010= controller heating mode only 0b0000 0011= controller cooling mode only 0b0000 0100=ventilating only (<i>PI loop controls fan stages only, valves closed</i>) Controller mode ECO: 0b0001 0000= controller off (<i>Frost protection active</i>) 0b0001 0001= controller auto mode (<i>heating + cooling</i>) 0b0001 0010= controller heating mode only 0b0001 0011= controller cooling mode only 0b0001 0100= ventilation only (<i>PI loop controls fan stages only, valves closed</i>) HMI mode 0b1xxx xxxx = HMI Mode, controller OFF 0b1xxx xx01 = show symbol "ventilating" 0b1xxx xx10 = show symbol "heating" 0b1xxx xx11 = show symbol "cooling" 0b1xxx x1xx = show symbol "AUTO mode" 0b1xxx x110 = show "AUTO + heating" symbol 0b1xxx x111 = show "AUTO + cooling" symbol 0b1xxx x101 = show "AUTO + ventilating" symbol 0b1xxx 1xxx = reserved		0
	515	0x0203	R/W	Active symbols 0x00= show none 0x01= show ECO-leaf 0x02= show dew point 0x04= show frost protect 0x08= show window open	0x10= show attention symbol 0x20= show hourglass 0x40= show lock -symbol 0x80= show ECO-writing	0
	516	0x0204	R/W	Control Variable Y% (HMI Mode) If output is 2-point, output will be ON for control variable >5%	0..100	
	517	0x0205	R/W	Room temperature on LCD (HMI Mode)	0..500 \triangle 0..+50,0 [°C]	
	519	0x0207	R/W	ASC calibration 0x00 = deactivated 0x01 = activated	0..1	0
	520	0x0208	R/W	FRC Correctionvalue Register for adjustment of the CO2 measuring value. (Reference measuring device for CO2 measurement adjustment recommended)	1..5000	0

» MOUNTING ADVICE/ DIMENSIONS (MM)

For installing or maintenance, please make sure the power is disconnected. Fix the thermostat base plate to the wall through the four screw holes with distance between axes of 60 mm. Fasten base plate and front cover. Do not press the panel in order to protect LCD.

